

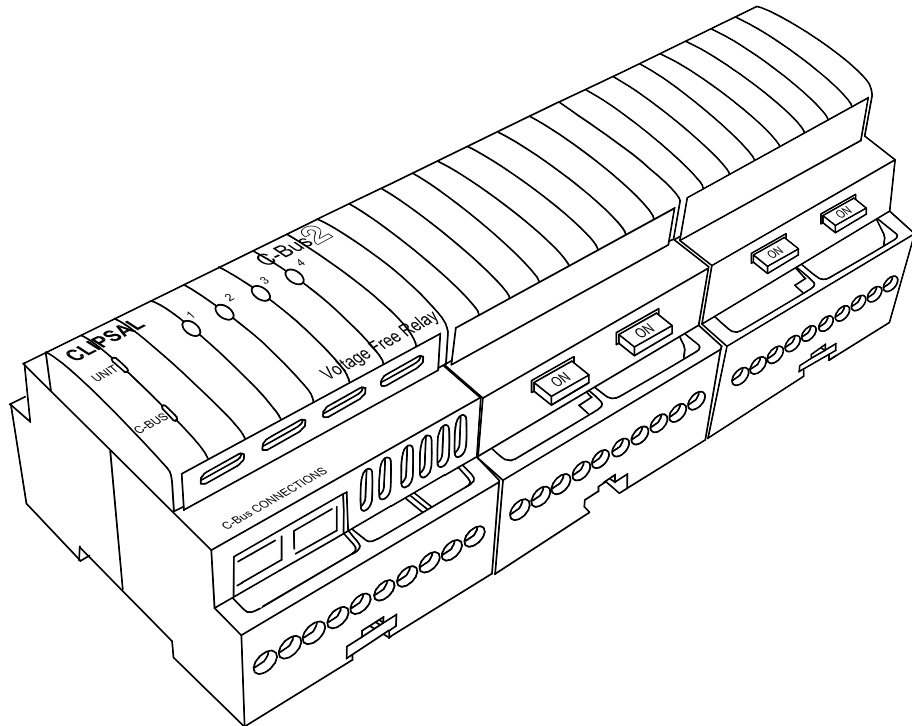

## C-Bus Four Channel Voltage Free Relay, 20A Installation Instructions

5504RVF20 Series



REGISTERED DESIGN  
REGISTERED PATENT



## Table of Contents

<b>Section</b>	<b>Page</b>
1.0 Product Range	3
2.0 Description	3
3.0 Capabilities	3
4.0 Compatible Loads	3
5.0 Wiring Instructions	4
6.0 Connection to the C-Bus Network	4
7.0 C-Bus DIN Rail Series Relay Features	5
7.1 Local Override Buttons	5
7.2 Remote Override Facility	6
8.0 Priority of Operating Modes	6
9.0 Status Indicators	7
9.1 C-Bus Indicator	7
9.2 Unit Indicator	7
10.0 C-Bus System Clock	7
11.0 C-Bus Network Burden	8
12.0 Power-Up Load Status	8
13.0 C-Bus Power Requirements	8
14.0 Stand-Alone Programming	9
15.0 Power Surges and Short Circuit Conditions	9
16.0 Megger Testing	9
17.0 Standards Complied	9
18.0 Programming Requirements	10
19.0 Important Warning	10
20.0 Mechanical Specifications	10
21.0 Electrical Specifications	11

### Copyright Notice

© Copyright 2003 Clipsal Integrated Systems Pty Ltd. All rights reserved.

### Trademarks

- Clipsal is a registered trademark of Gerard Industries Pty Ltd.
  - C-Bus and C-Bus2 are registered trademarks of Clipsal Integrated Systems Pty Ltd.
  - Intelligent Building Series is a registered trademark of Clipsal Integrated Systems Pty Ltd.
- All other logos and trademarks are the property of their respective owners.

### Disclaimer

Clipsal Integrated Systems reserves the right to change specifications or designs described in this manual without notice and without obligation.

## 1.0 Product Range

<b>L5504RVF20</b>	Four Channel VF Relay, 20A with C-Bus Power Supply (220-240V, 50-60 Hz)
<b>L5504RVF20P</b>	Four Channel VF Relay, 20A (220-240V, 50-60 Hz)
<b>LE5504TRVF20</b>	Four Channel VF Relay, 20A with C-Bus Power Supply (110-120V, 50-60 Hz)
<b>LE5504TRV20P</b>	Four Channel VF Relay, 20A (110-120V, 50-60 Hz)

## 2.0 Description

The 5504RVF20 Series C-Bus Four Channel Voltage Free Relay products are C-Bus output devices, designed to be used in a switchboard application. For ease of installation they are DIN rail mounted, measuring 12M wide (1M = 17.5 +0.5/-0.0 mm) wide. C-Bus connection is conveniently achieved through the use of RJ45 connectors, allowing similar units to be quickly looped together. Four independent voltage free relay contacts are provided for general switching applications.

## 3.0 Capabilities



The 5504RVF20 Series products have an internal C-Bus power supply capable of supporting a number of other C-Bus units (200mA capacity). All units with a suffix "P" do not have a C-Bus power supply, but consume no current from the C-Bus Network during normal operation.

These units also generate a C-Bus system clock signal, therefore providing all the support necessary for a simple C-Bus Network. Local toggle buttons are provided on each unit to allow individual channels to be toggled at each unit or via C-Bus commands. Remote ON and OFF facilities are available, permitting all channels to be turned ON or OFF without C-Bus Network communications.

These units isolate mains power from the extra low voltage C-Bus Network.

## 4.0 Compatible Loads

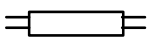
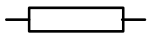
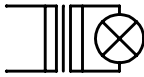
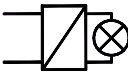
The 5504RVF20 Series C-Bus Four Channel Voltage Free Relay unit is suitable for use with resistive (incandescent), inductive and fluorescent loads.

Load Symbol	Compatible Loads	Maximum Total Load Rating
	Incandescent lighting Halogen 240V lamps	20A
	Fluorescent lighting	20A
	Resistive load	20A
	Low voltage lighting with iron-core transformers	20A
	Low voltage lighting with electronic transformers	
	Exhaust fans (shaded pole induction motors) * Ceiling fans (split-phase induction motors) *	

\* The installer must ensure an appropriate isolating circuit breaker is installed with the motor in order to comply with local wiring rules applicable to the region.

## 5.0 Wiring Instructions

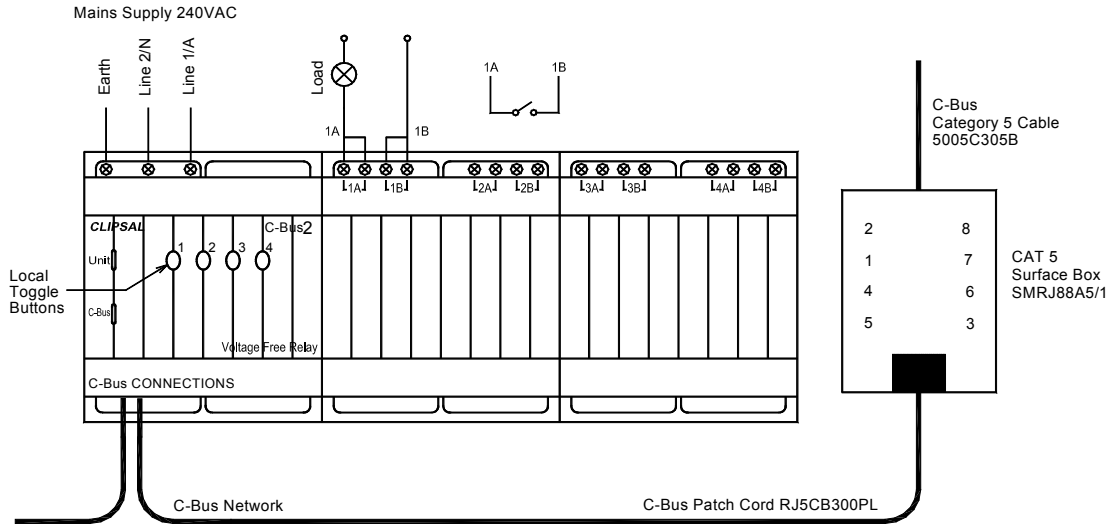

### NOTE:

- The unit is capable of handling up to four channels of 20A switched active loads. The installer should make adequate consideration for the total current consumption when selecting power feed cables. It is recommended the installer allow for multiple feed cables.
- A maximum of 10 C-Bus DIN Rail units (with 200mA power supply) can be connected to a single C-Bus Network. A maximum of 100 "P" suffix units may be interconnected.
- The installer must fix mains cables in the distribution board using cable ties or trunking as required by local wiring rules. Care must be taken not to allow copper strands to enter the DIN unit's apertures.
- A maximum torque of 1.4Nm should be applied to the mains rated screw terminals.
- Rubber bungs are supplied (3 off) for unused RJ45 connectors, to stop foreign bodies from entering the unit. Always ensure these bungs are installed when the Relay Unit is to be mounted inside a mains rated enclosure.

## 6.0 Connection to the C-Bus Network

Installation requires connection to the unshielded twisted pair C-Bus Network Cable. The illustration opposite, shows the recommended technique for cable termination giving the best electrical performance. It is required that Category 5 data cable is used, Clipsal catalogue number 5005C305B.

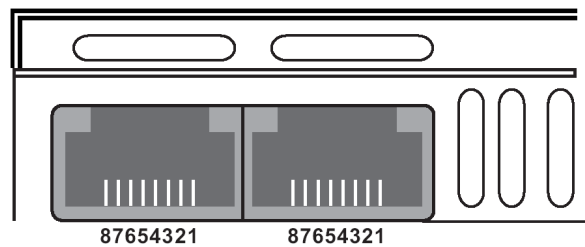

RJ Pin	C-Bus Connection	Colour
1	Remote ON	Green/White
2	Remote ON	Green
3	C-Bus Neg (-)	Orange/White
4	C-Bus Pos (+)	Blue
5	C-Bus Neg (-)	Blue/White
6	C-Bus Pos (+)	Orange
7	Remote OFF	Brown/White
8	Remote OFF	Brown

**NOTE:**

- It is recommended that the Remote Override (On/Off) connections be maintained for correct operation of these services across the C-Bus Network, even if they are not intended to be used. Remote Override services may be disabled in software if necessary.
- A Clipsal RJ5CB300PL Cat UTP patch cord is included with the unit for easy interconnection. No more than 10 x 5504RVF20 Series products should be connected to one physical C-Bus Network. This may be extended to 100 for "P" suffix units.
- Rubber bungs are supplied (3 off) for unused RJ45 connectors, to stop foreign bodies from entering the unit. Always ensure these bungs are installed when the Relay Unit is to be mounted inside a mains rated enclosure.

**7.0 C-Bus DIN Rail Series Relay Features****7.1 Local Override Buttons**

The buttons located on the front of the unit provide a means to toggle each channel locally (at the unit). Each button is illuminated when the respective channel is in the On state.

Operation	Function
Short Press	One short press will toggle the state of this channel only
Double Click	Two short presses within 2 seconds will return this channel only to the C-Bus Network level
Long Press	Pressing any of the Local Override buttons for longer than 2 seconds will return all channels to the C-Bus Network level

Note double-click and long press operations will only occur if the unit/channel is already in override mode.

C-Bus commands received by the unit will (by default) override local toggle changes. In this case, only the channel associated with the received commands will revert to the current C-Bus Network state. This option may be disabled in software. Please refer to Section 8.0, Priority of Operating Modes.

### 7.2 Remote Override Facility

Remote control of all channels on a unit can be achieved via the extra pairs of conductors on the C-Bus connector. The diagram opposite shows switches may be connected in parallel on any one Network, using green and green/white conductors for the remote ON function. Brown brown/white may be wired in the same fashion for remote OFF, with these conductors being connected to C-Bus negative via the switch to action this state. A Clipsal 30/1/2LM mechanism makes an ideal remote input switch.

**NOTE:**

C-Bus is a balanced network and therefore at any point where C-Bus negative (-) is taken, C-Bus positive (+) must also be present. Hence both network conductors must be looped through all remote input switches on the Network.

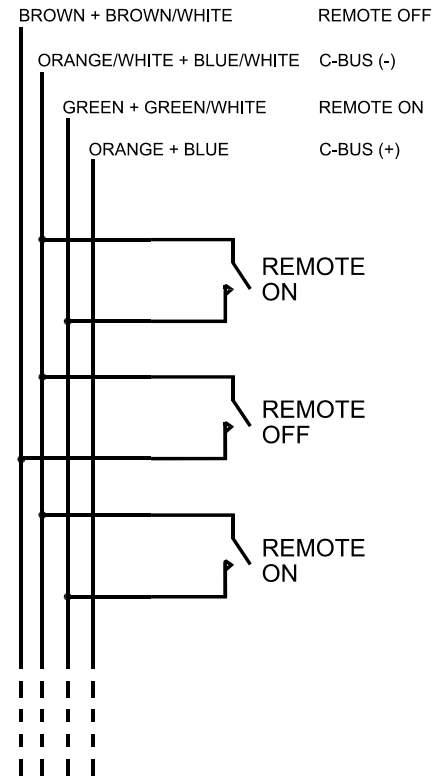

### 8.0 Priority of Operating Modes

The output status of the 5504RVF20 Series C-Bus Four Channel Voltage Free Relay product can be changed by:

- Pressing a C-Bus Key,
- By activating any of the Local Override buttons or
- By using the Remote Override facilities.

The table below shows the priority ranking of these control inputs,

Mode	Priority	Function
Remote OFF	1 (Highest)	Turns all channels OFF
Remote ON	2	Turns all channels ON
Local Override	3*	Toggle channel
C-Bus Input Unit (Key, PIR etc)	4* (Lowest)	Control the channel

\* Local Override has priority over normal C-Bus commands received on the bus (such as those generated by pressing a C-Bus Key). By default, if any channel is in Local Override mode and a C-Bus command is received for that channel, the C-Bus command state will be imposed (“Enable C-Bus Priority” option). This feature can be disabled in software so all relevant C-Bus commands will be ignored by the unit when it is in Local Override Mode.

For further information about the programming this and other C-Bus units, please refer to the C-Bus Technical Manual (5000S/2, 5000M/2).

## 9.0 Status Indicators

### 9.1 C-Bus Indicator

This indicator shows the status of the C-Bus Network at this unit. If sufficient network voltage and a valid C-Bus Clock signal are present then the 'OK' signal will be displayed (continuous green light). If a Network is connected which has more current load than the power supplies can support, then this indicator will flash to show a marginal Network voltage. If there is no C-Bus Clock present then this indicator will not light. When the unit is powered from C-Bus only, for stand-alone programming, this indicator will not function.

Indicator Status	Meaning
On	Power on and functional
Flashing	Insufficient power to support Network
Off	No C-Bus Clock signal present; No mains connected

Further debugging of possible Network problems can be achieved with the Clipsal C-Bus Network Analyser tool (5100NA).

### 9.2 Unit Indicator

This indicator shows the status of the individual unit. When mains is supplied to the unit, 'OK' will be displayed (continuous green light). If any of the four channels have been toggled (using Override facilities) into a state other than is present on the C-Bus network, this indicator will flash with a 90% ON duty cycle. This applies to either Local or Remote Override inputs. When the unit is powered from C-Bus only for stand-alone programming, this indicator will not function.

Indicator Status	Meaning
On	Normal operation
Flashing	Unit in override mode
Off	No mains connected

## 10.0 C-Bus System Clock

The 5504RVF20 Series C-Bus Four Channel Voltage Free Relay product incorporates a software selectable C-Bus System Clock. The System Clock is used to synchronise data communications waveforms on a C-Bus Network. At least one active C-Bus System Clock is required on each C-Bus Network for successful communications. No more than three units on any C-Bus Network should have Clock circuitry enabled, so this option should normally be disabled using the C-Bus Installation Software.

If a System Clock is required, it can be enabled from the 'Global Tab' on the Graphical User Interface (GUI) for the unit.

### 11.0 C-Bus Network Burden

The 5504RVF20 Series C-Bus Four Channel Voltage Free Relay product incorporates a software selectable Network Burden. The Network Burden can be enabled using the C-Bus Installation Software.

A Network Burden may or may not be required to ensure correct operation of the C-Bus Network. If in doubt, consult the C-Bus Calculator (Network Design Verification Software Utility) before proceeding with the hardware installation.

#### **CAUTION:**

The Graphical User Interface (GUI) software is designed to prevent the Burden from accidental selection. The following steps are required to correctly enable the Network Burden from the GUI:

1. Set the Unit Address to '001';
2. Turn to the 'Global Tab' of the GUI;
3. Select the Network Burden check box (cross inside box for ON);
4. Click the OK button;
5. Select 'Save to Network' and/or 'Save to Database';
6. Click the OK button; then
7. Repeat steps 3 and 4 within 20 seconds, to save your selection.

To disable the Network Burden the same process applies except the Burden selection check box is cleared (remove cross).

---

#### **Important Note:**

Always disable all 5100 PC Interface Network Burdens before installing C-Bus DIN range products, which include a power supply (non "P" suffix versions). If a burden is required, use the built-in burden on the DIN Rail unit only.

---

### 12.0 Power-Up Load Status

All C-Bus units have onboard non-volatile memory, which is used to store the operating state of the unit in case of power loss. The 5504RVF20 Series products incorporate latching relays and will retain their current output status if C-Bus power is lost. On restoration of power the DIN Rail Relay unit initiates a short power-up diagnostic routine, which lasts for approximately 5 seconds. User programmable options will then allow the relay status to be set as desired.

For further information about the programming this and other C-Bus units, please refer to the C-Bus Technical Manual (5000S/2, 5000M/2).

### 13.0 C-Bus Power Requirements

The 5504RVF20 Series C-Bus Four Channel Voltage Free Relay is available in several different configurations. All variants draw 18mA from the C-Bus Network when not connected to the mains supply. With mains connected, these units draw no current from the C-Bus Network.

In addition, a unit whose catalog number does not include a "P" suffix (such as the L5504RVF20) can supply up to 200mA to the Network when it is connected to the mains. "P" suffix variants (such as the L5504RVFP) do not include the 200mA power supply.



Adequate C-Bus Power Supply Units must be installed to support the connected devices. If in doubt, consult the C-Bus Calculator (Network Design Verification Software Utility) before proceeding with the hardware installation.

#### 14.0 Stand-Alone Programming

The 5504RVF20 Series C-Bus Four Channel Voltage Free Relay products can be programmed without a mains connection. The unit can be connected to any operational C-Bus Network that is capable of supporting one or more extra C-Bus units (18mA current required). The unit can then be configured using the C-Bus Installation Software. Indicators and relays will only function when a mains connection is made.

#### 15.0 Power Surges and Short Circuit Conditions

The mains voltage must be limited to the range specified for any unit which is mains powered. Each Unit incorporates transient protection circuitry. Additional external power surge protection devices should be used to enhance system immunity to power surges. It is strongly recommended that overvoltage equipment such as the Clipsal 970 be installed at the switchboard.

#### 16.0 Megger Testing

Megger testing must never be performed on the C-Bus data cabling or terminals as it may degrade the performance of the Network.

Megger testing of mains wiring of an electrical installation that has C-Bus Units connected will not cause any damage to C-Bus Units. Since C-Bus Units contain electronic components, the installer should interpret megger readings with due regard to the nature of the circuit connection.

#### 17.0 Standards Complied

Standard/Directive	Title
AS/NZS 3100:1997	General Requirements for Electrical Equipment
AS/NZS 1044:1995; IEC/CISPIR 14/1993; BS/EN 55014:1994	Limits and Methods of Measurement of Radio Disturbance Characteristics of Electrical Motor-Operated and Thermal Appliances for Household and Similar Purposes, Electric Tools and Similar Electric Apparatus
IEC 60669-2-1:1996 EN 60669-2-1:2000	Switches for Household and Similar Fixed Installations – Part 2: Particular Requirements, Electronic Switches
AS/NZS 61000-3-2:1998; IEC 61000-3-2:1995; EN 61000-3-2:1995	Low Frequency Emissions

## 18.0 Programming Requirements

The 5504RVF20 Series C-Bus Four Channel Voltage Free Relay must be programmed to set a unique identification (Unit Address) and mode of operation on the C-Bus Network. C-Bus Installation Software v2.2.0 (or higher) can be used to configure the:

- Project Name
- Part Name
- Unit Address
- Clock (Enable/Disable)
- Network Burden (Enable/Disable)
- Relay Switching Relationships
- Other Advanced Operating Parameters (e.g. Logic Relationships, Turn-On Thresholds, Power Fail Options etc).

The C-Bus Installation Software can be downloaded from the Clipsal Integrated Systems Web Site ([www.clipsal.com/cis](http://www.clipsal.com/cis)).

For further information about the programming this and other C-Bus units, please refer to the C-Bus Technical Manual (5000S/2, 5000M/2).

The 5504RVF20 Series Relay products can also be programmed using C-Bus2 Learn Mode. For further information about Learn Mode, please consult the C-Bus2 Learn Mode Operations and Programming Guide.

## 19.0 Important Warning

The use of any non-approved software in conjunction with the hardware installation without the written consent of Clipsal Integrated Systems may void any warranties applicable to the hardware.

## 20.0 Mechanical Specifications

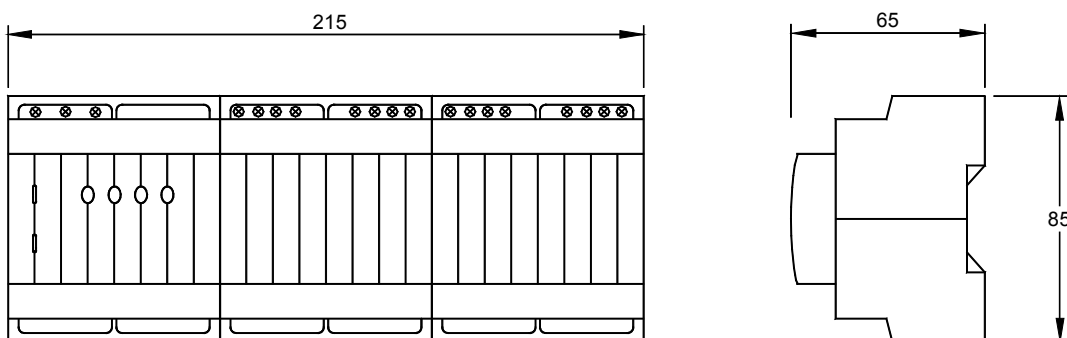

All dimensions are in millimeters.  
No user serviceable parts inside.

## 21.0 Electrical Specifications

Catalogue No.	L5504RVF20	L5504RVF20P	LE5504TRVF20	LE5504TRV20P
<b>Nominal Supply Voltage</b>	220-240V~		110-120V~	
<b>Frequency Range(s)</b>	47-53Hz and 57-63Hz			
<b>C-Bus Supply Voltage</b>	15-36V DC @ 18mA required for programming when mains is not connected. Sources 200mA to the C-Bus Network with mains connected.	15-36V DC @ 18mA required for programming when mains power is not connected. 15-36V DC @ 0mA required for programming when mains power is connected. Does not source current to the C-Bus Network.	15-36V DC @ 18mA required for programming when mains is not connected. Sources 200mA to the C-Bus Network with mains connected.	15-36V DC @ 18mA required for programming when mains power is not connected. 15-36V DC @ 0mA required for programming when mains power is connected. Does not source current to the C-Bus Network.
<b>AC Input Impedance</b>	50kΩ @1kHz A maximum of 10 units may be connected on a single C-Bus Network	100kΩ @1kHz A maximum of 100 units may be connected on a single C-Bus Network	50kΩ @1kHz A maximum of 10 units may be connected on a single C-Bus Network	100kΩ @1kHz A maximum of 100 units may be connected on a single C-Bus Network
<b>Electrical Isolation</b>	3.75kV RMS from C-Bus to Mains			
<b>Status Indicators</b>	<b>C-Bus Indicator</b> Voltage ≥ 20V DC Voltage < 20V DC Voltage < 15V DC <b>Unit Status Indicator</b> On Flashing Off <b>Load Indicators (4)</b> Load indicator is On when relay output is on	<b>Clock Present</b> On Flashing Off <b>Mains Power</b> Present Present Fail	<b>No Clock Present</b> Off Off Off <b>Conditions</b> Normal Operations At least one channel in Local or Remote Override mode Mains power not available	
<b>Maximum Number of Units on a Single C-Bus Network</b>	10	100	10	100
<b>Load Rating</b>				
Resistive	20A		20A	
Inductive	20A		20A	
Fluorescent	20A		20A	
<b>Contact Type</b>	Voltage Free, Magnetically Latched – Normally Open			
<b>Switch Operations</b>	Greater than 60,000 operations			
<b>Quiescent Power</b>	4 Watts			
<b>Warm Up Time</b>	5 seconds			
<b>Restart Delay</b>	0 seconds to 42 minutes and 30 seconds			
<b>Network Clock</b>	Software selectable			
<b>Network Burden</b>	Software selectable			
<b>Dimensions</b>	215 x 85 x 65			
<b>Remote Override</b>	Remote switch input can be daisy chained to a maximum of 10 units and a maximum of 1000m of cable	Remote switch input can be daisy chained to a maximum of 100 units and a maximum of 1000m of cable	Remote switch input can be daisy chained to a maximum of 10 units and a maximum of 1000m of cable	Remote switch input can be daisy chained to a maximum of 100 units and a maximum of 1000m of cable
<b>Mains Terminals</b>	Accommodates 2 x 1.5mm <sup>2</sup> or 1 x 2.5mm <sup>2</sup>			
<b>Weight</b>	580g			
<b>C-Bus Connections</b>	2 x RJ45 sockets			
<b>Operating Temperature Range</b>	0-45°C			
<b>Operating Humidity Range</b>	10 – 95% RH			

## Further Information

For further information about configuring this product and other C-Bus devices, please consult the documentation supplied. Further assistance can be obtained as follows:

- **C-Bus Manuals**  
The 5000M/2 C-Bus Technical Manual provides a comprehensive and definitive guide to Clipsal C-Bus. Includes hardware and software specifications, product datasheets, system design and installation guides, and software overview with fully worked programming examples.
- **C-Bus Installation Software**  
The 5000S/2 C-Bus Installation Software (includes 5000M/2 C-Bus Technical Manual) may be used to unlock the power and flexibility of Clipsal C-Bus. Unit operation may be completely customised to suit user requirements. Advanced control functions may be programmed.
- **C-Bus Installer Training Courses**  
Contact your nearest Clipsal Integrated Systems Sales or Technical Support Officer and enquire about Clipsal C-Bus Installer Training and Certification Programs today !!
- **Technical Support and Troubleshooting**  
For further assistance, please consult your nearest Clipsal Integrated Systems Sales Representative or Technical Support Officer.

<b>Technical Support Hotline</b>	1 300 722 247 (Cost 25¢ per call, Australia Only)
<b>Technical Support Email</b>	techsupport.cis@clipsal.com.au
<b>Sales Support Email</b>	sales.cis@clipsal.com.au
<b>Clipsal Integrated Systems Website</b>	clipsal.com/cis

## Products of Clipsal Integrated Systems Pty Ltd

ABN 15 089 444 931

### Head Office

12 Park Terrace, Bowden  
South Australia 5007

International Phone +61 8 8269 0560  
International Fax +61 8 8346 0845  
Internet clipsal.com/cis  
E-Mail cis@clipsal.com.au

1036438